

1

p

Manfred Maier

Procesos elementales de proyectación
y configuración

r

O

C

Curso básico de la Escuela de Artes Aplicadas
de Basilea (Suiza).

1 Dibujo de objetos
Dibujo de modelos y copia de museo
Estudios de la naturaleza

e

S

O

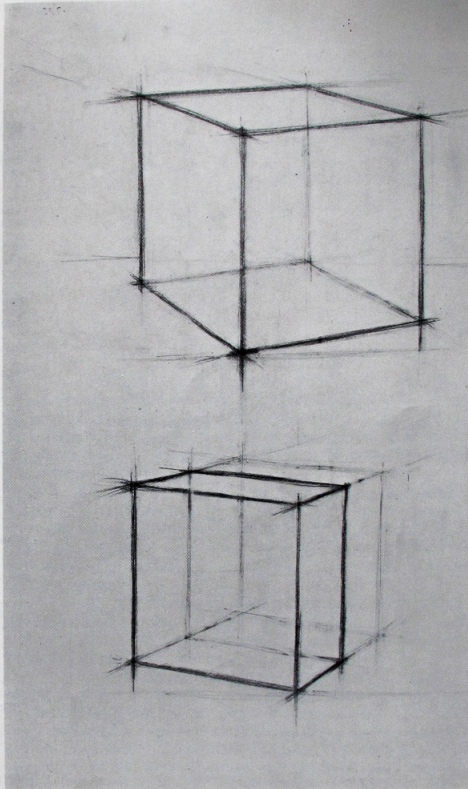
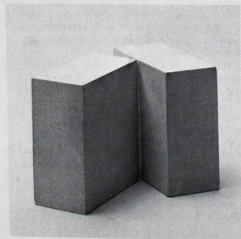
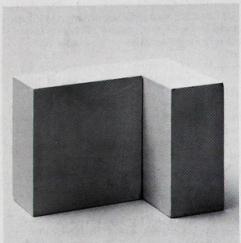
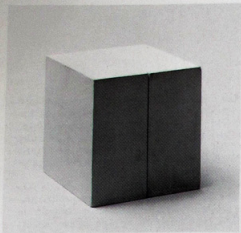

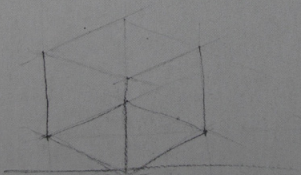
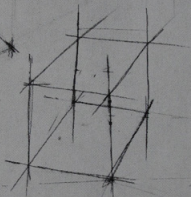
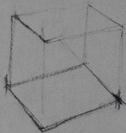
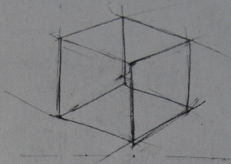
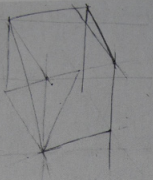

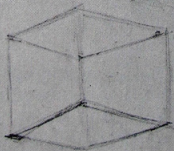
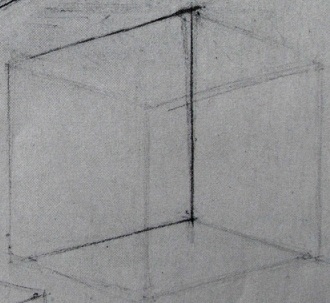
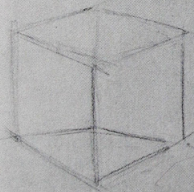
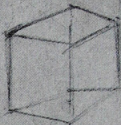
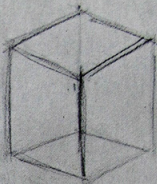
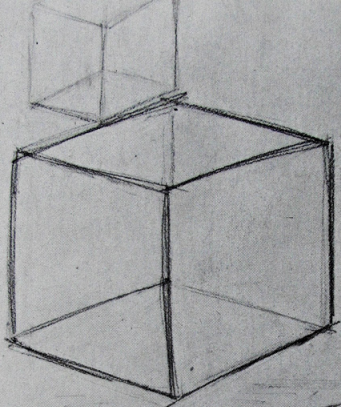

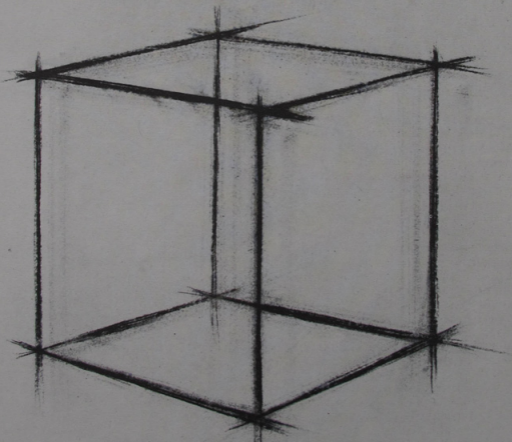
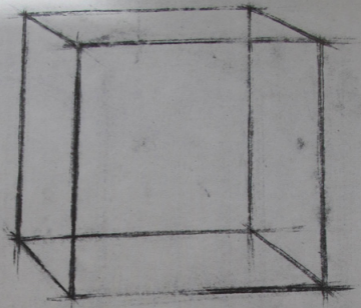

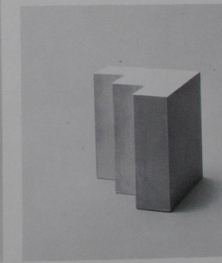
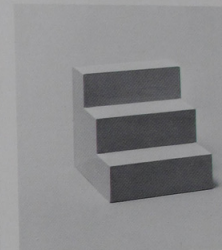
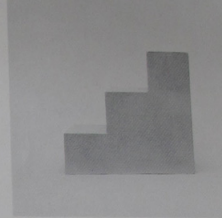
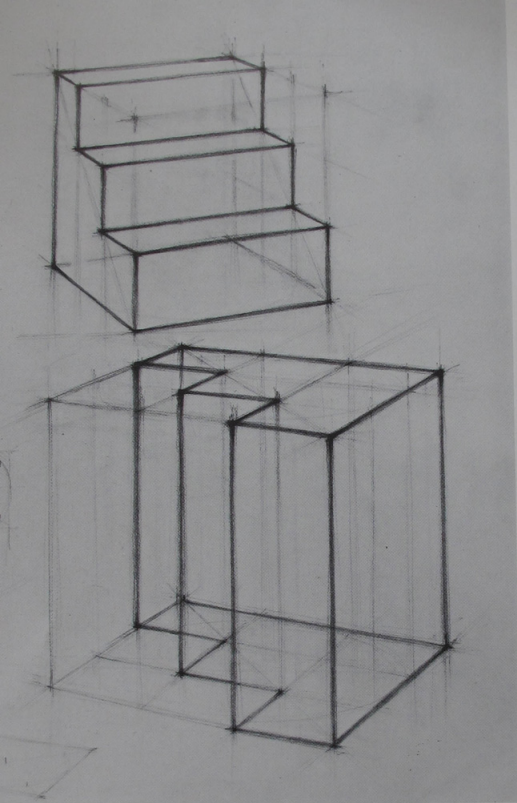

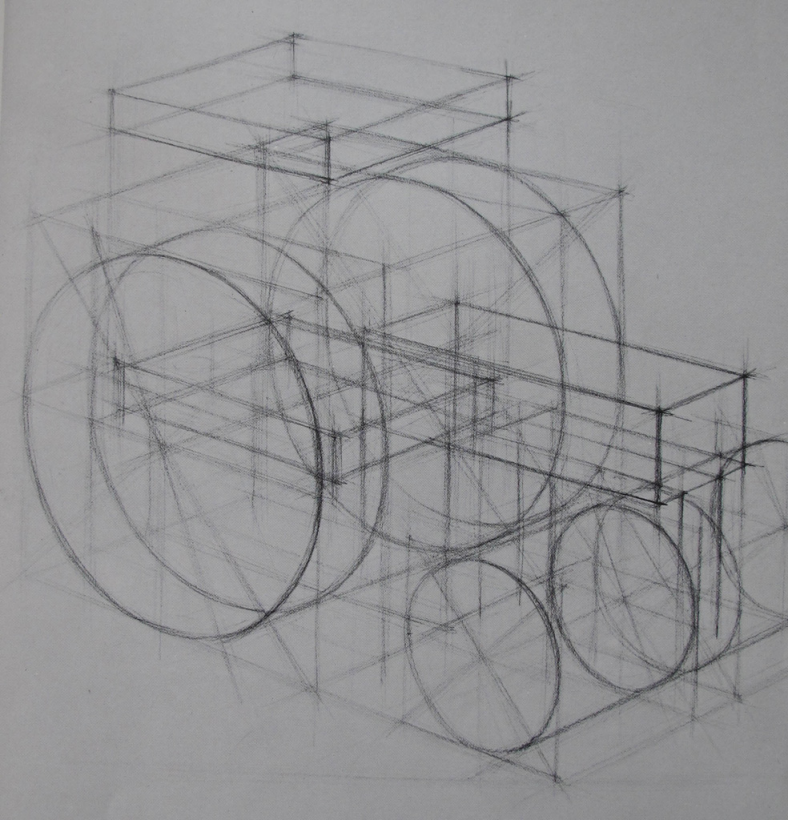

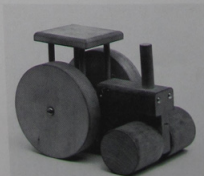
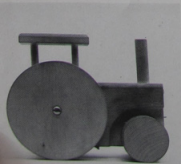
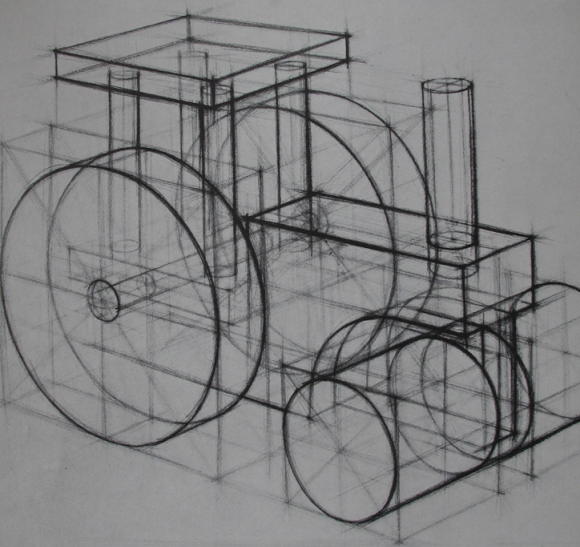

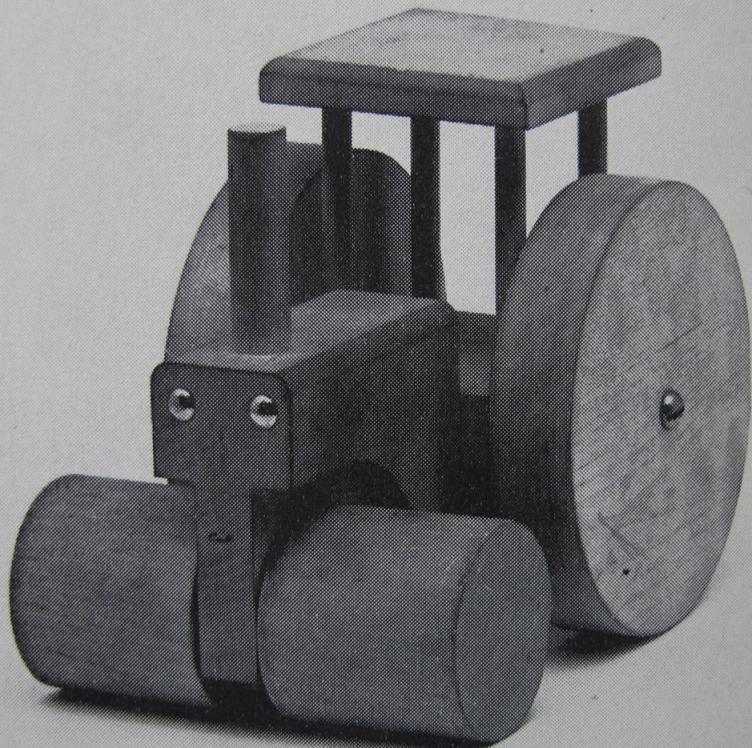

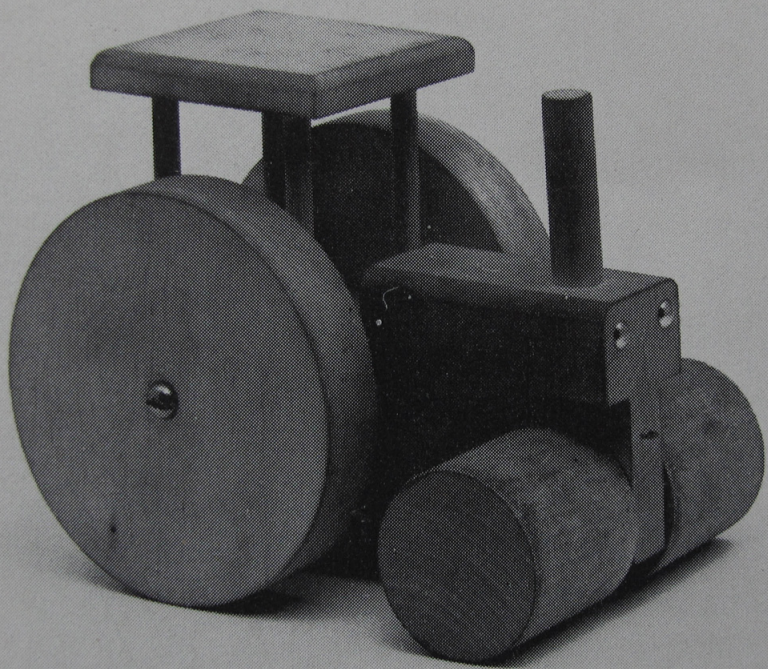

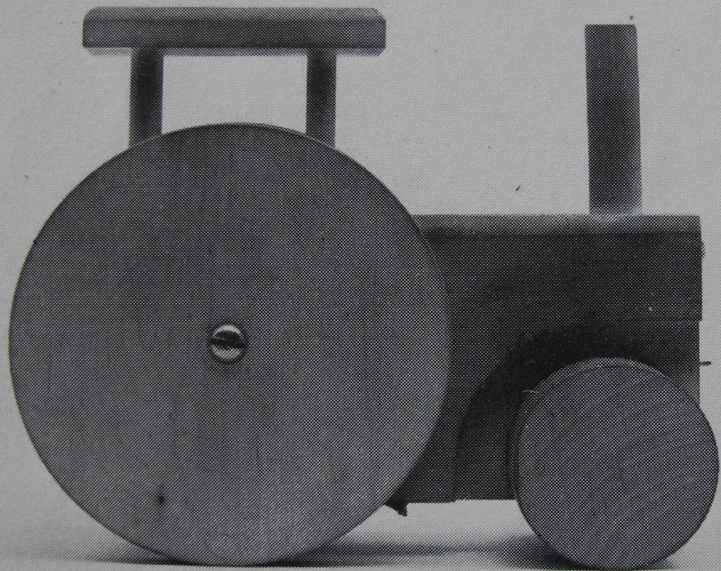

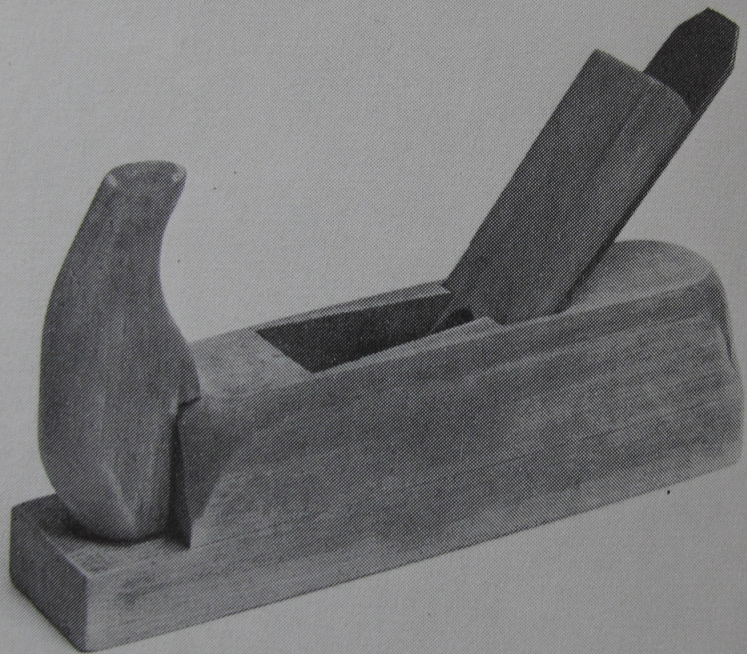

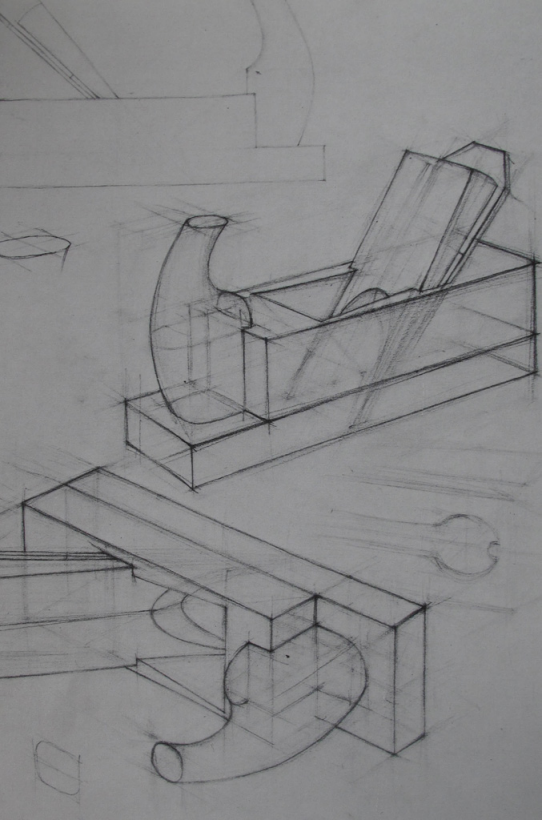

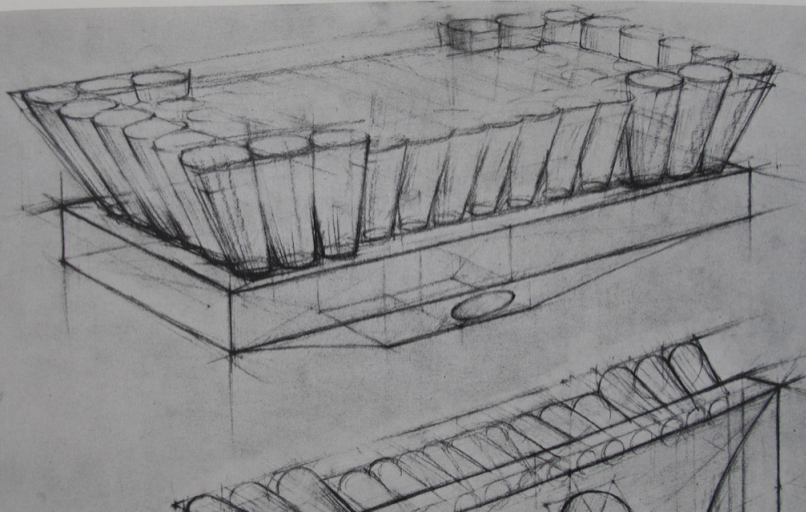

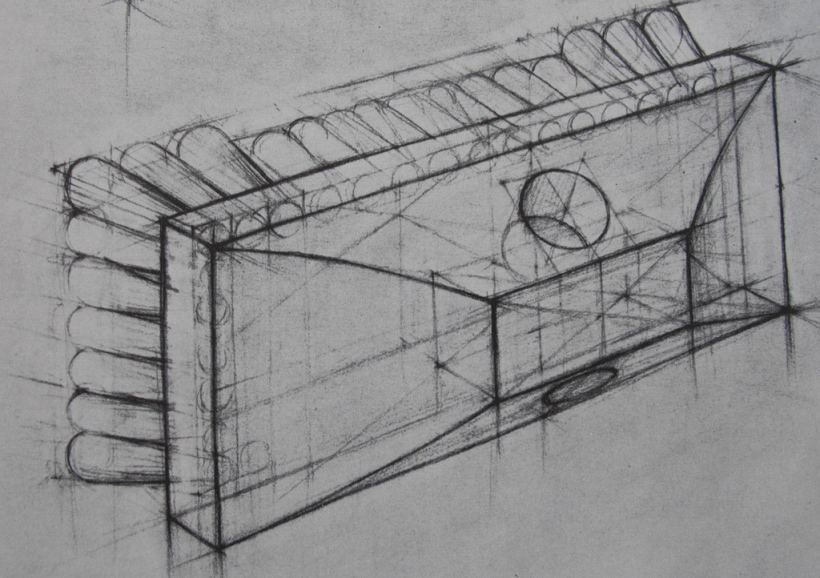

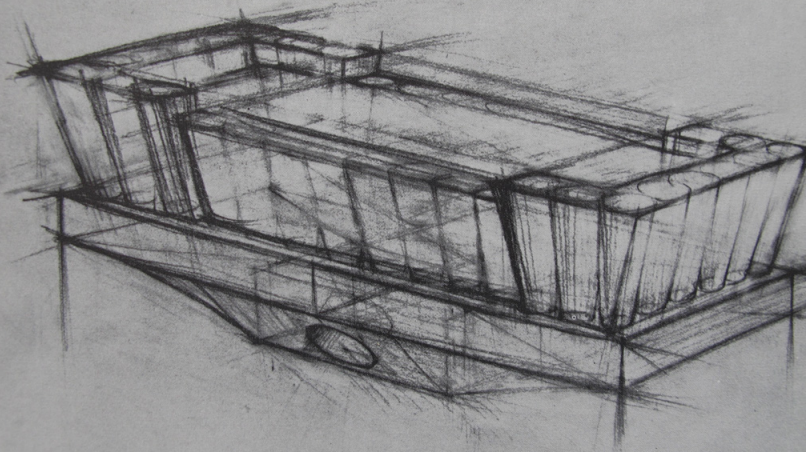

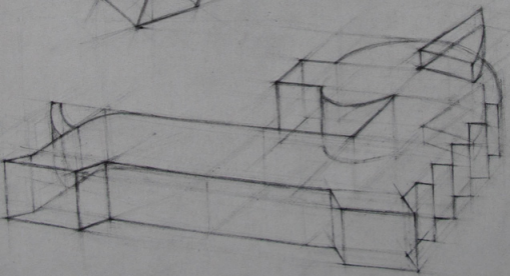
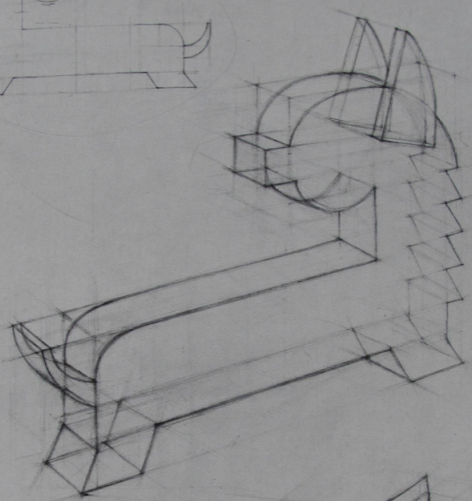
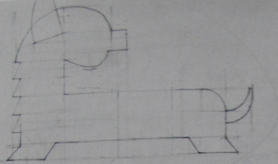

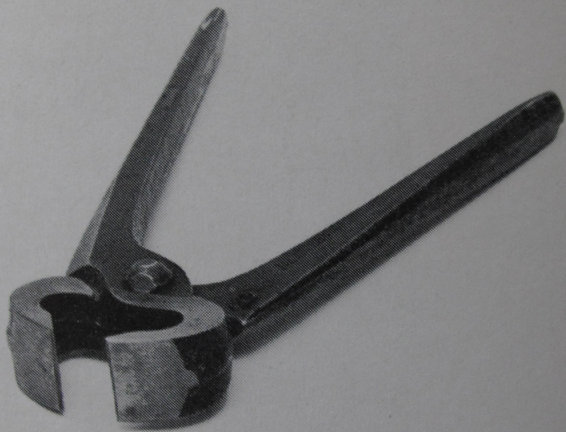

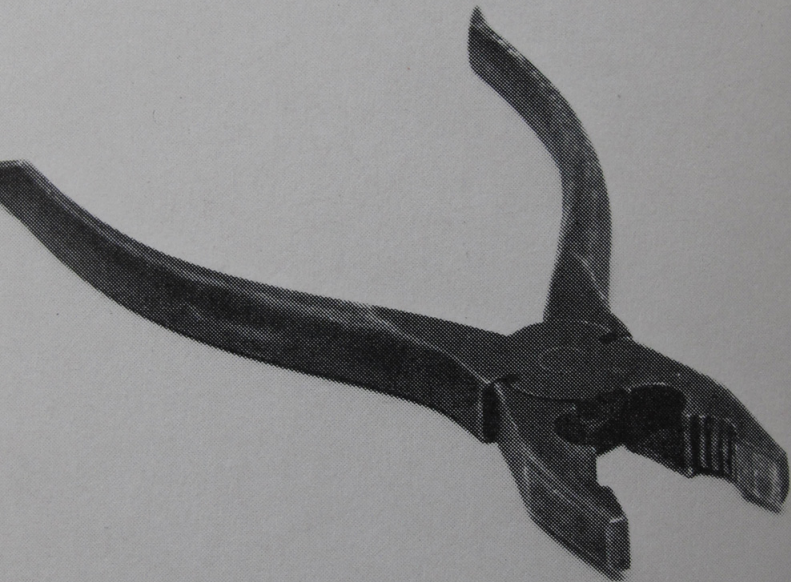



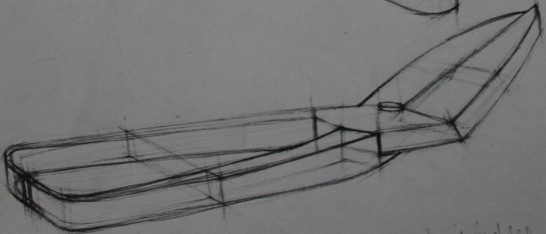
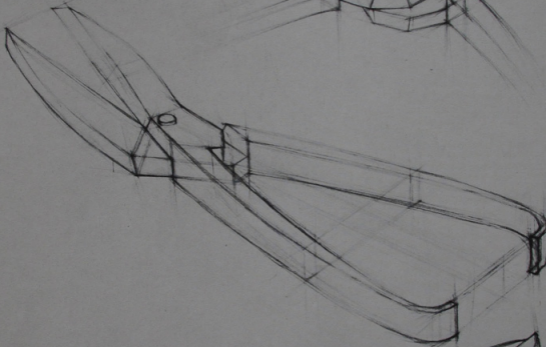
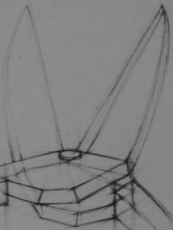
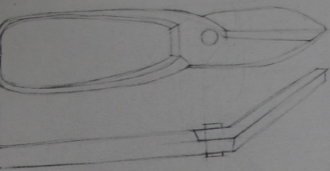

Finnish Patent 239

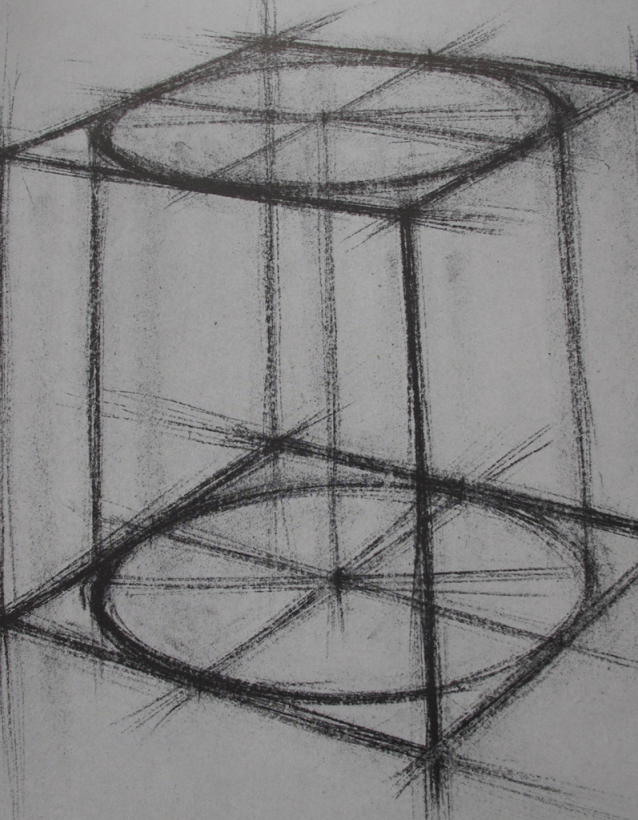

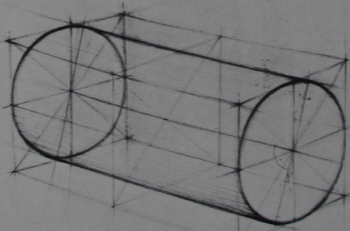
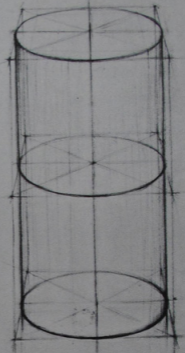
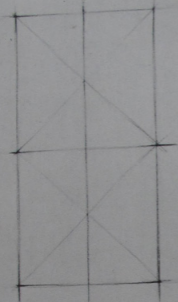

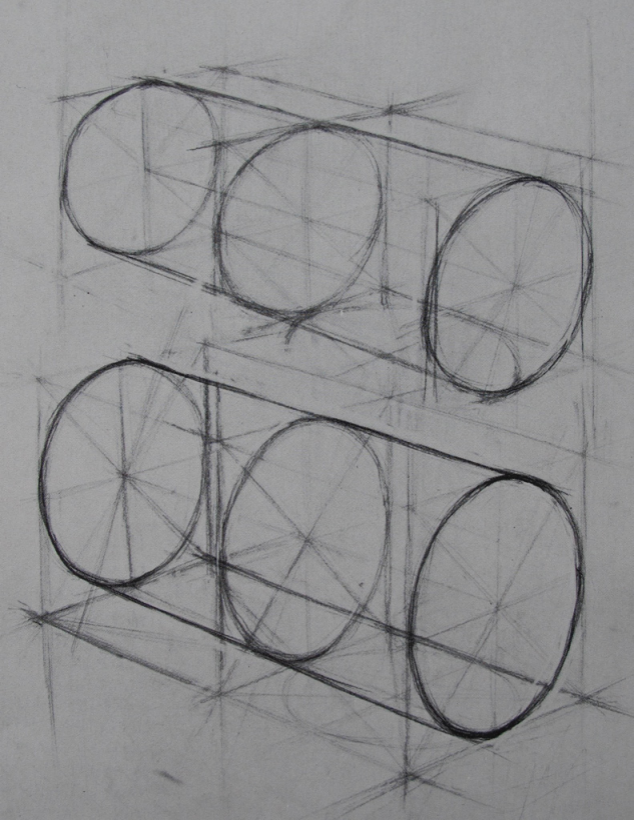

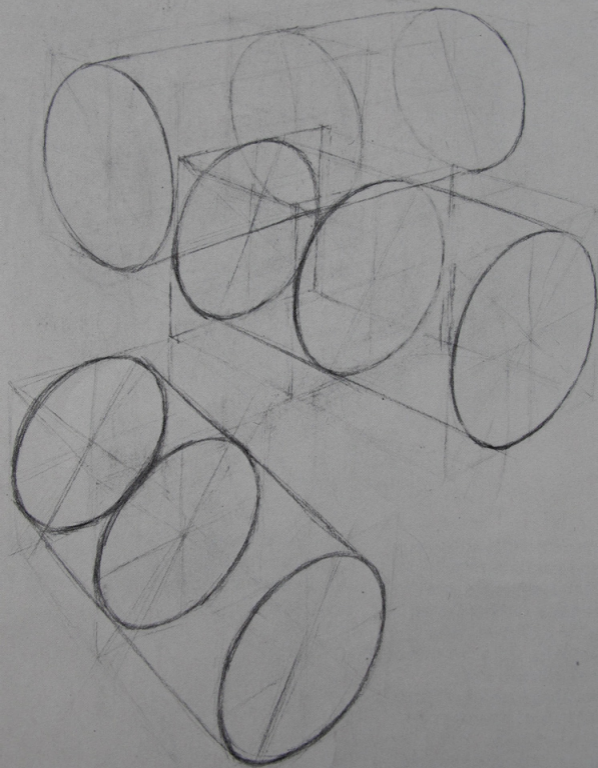

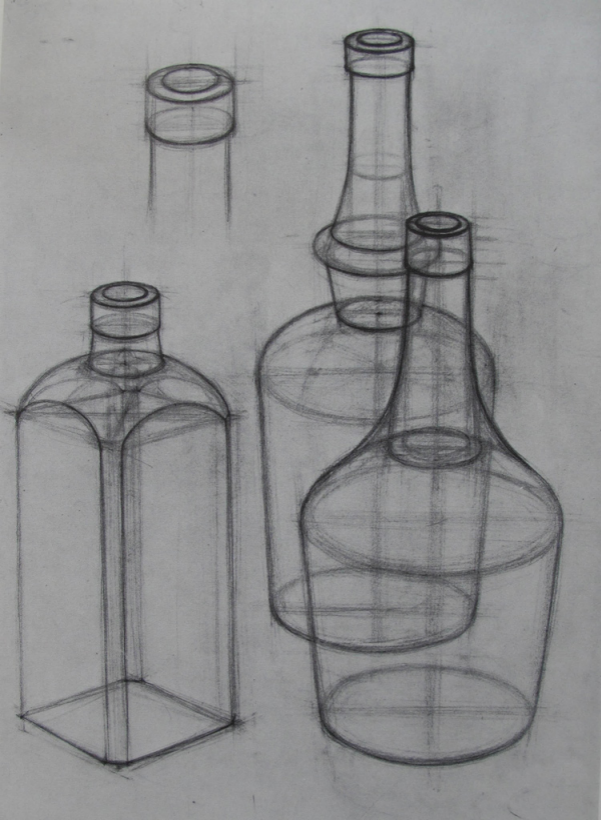

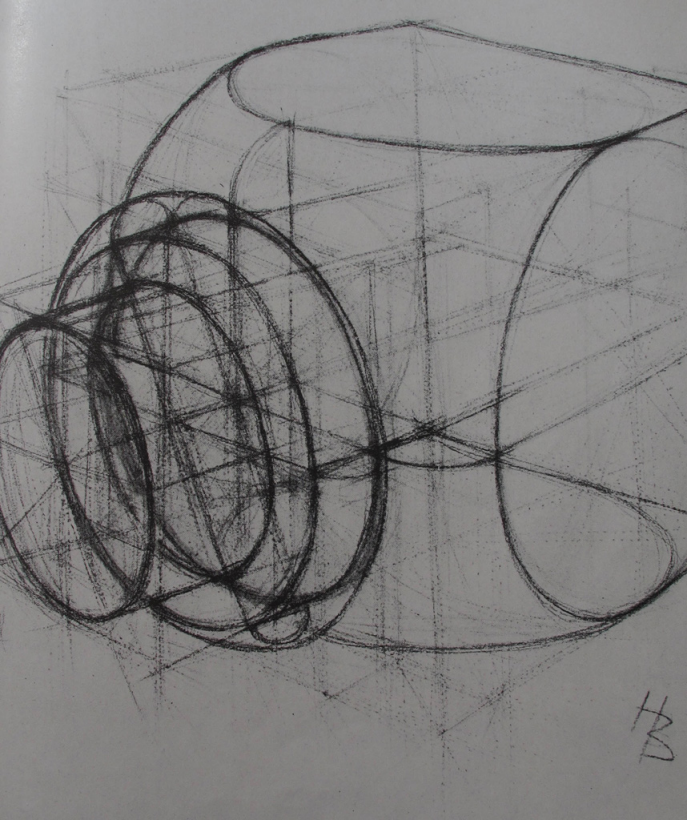

H B

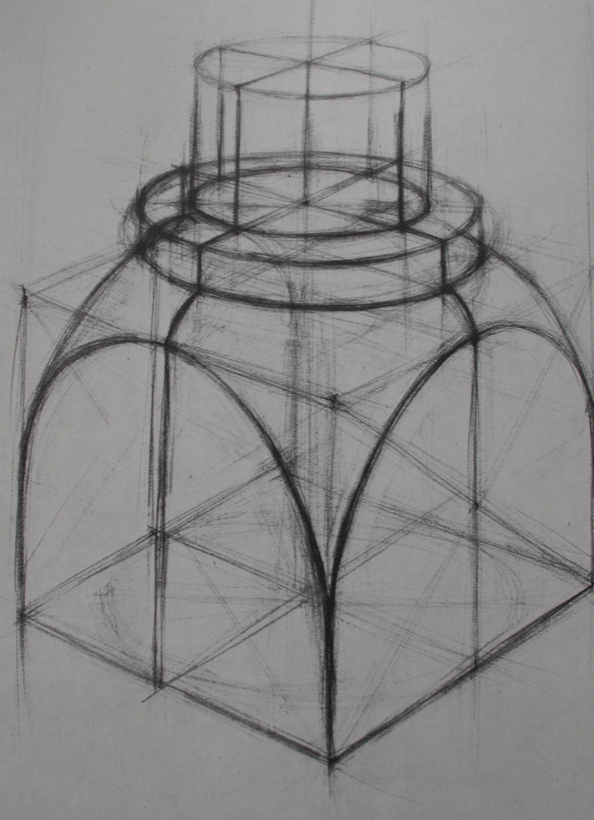





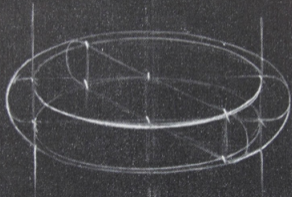
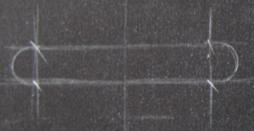

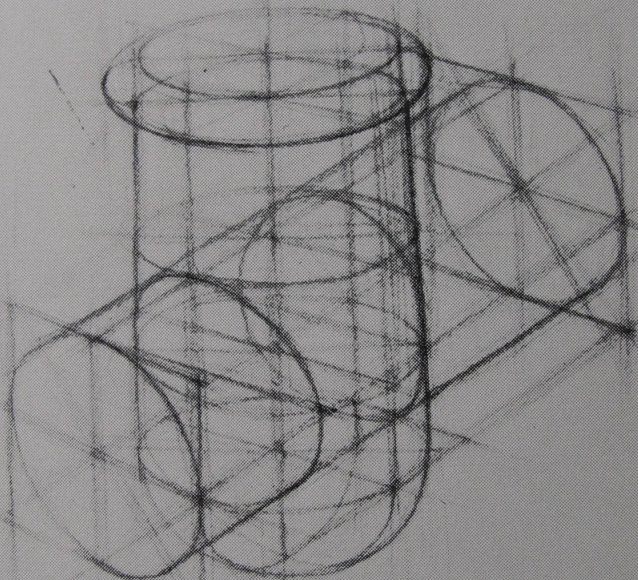

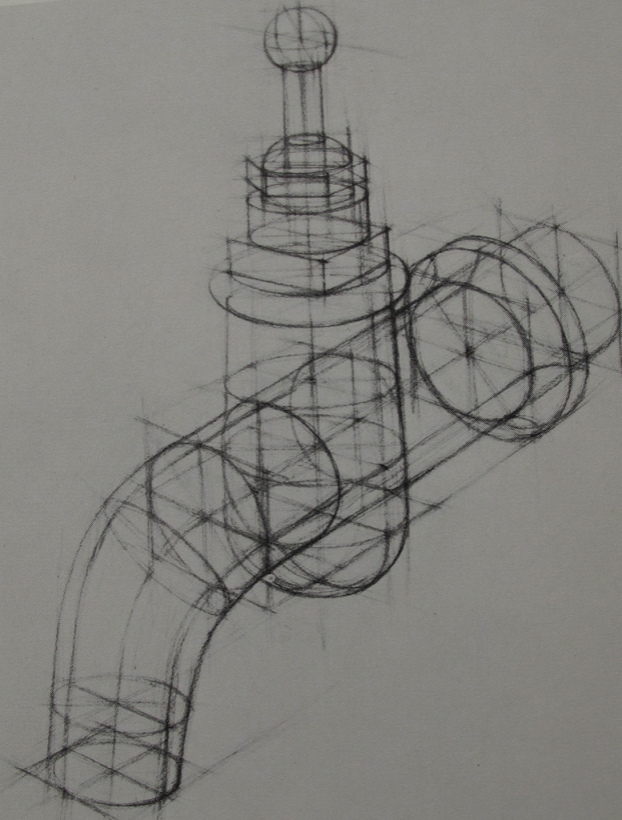

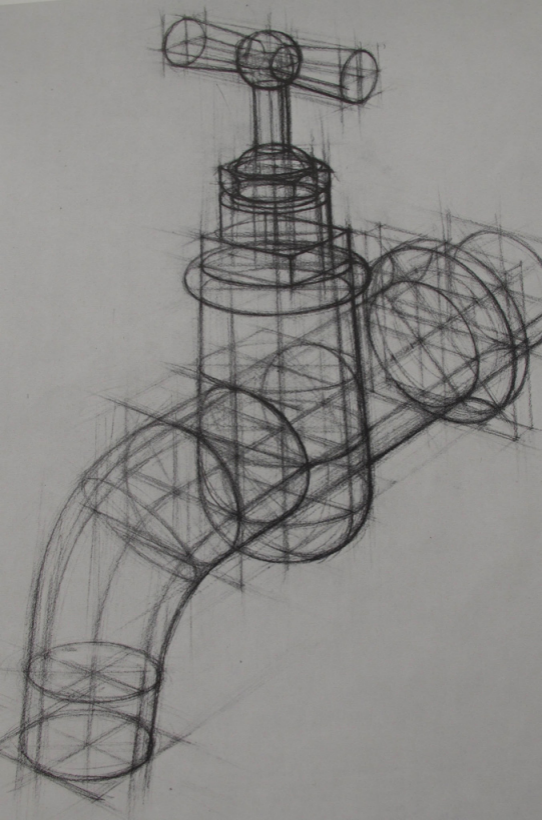

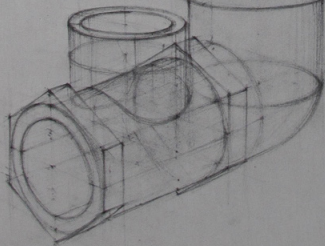
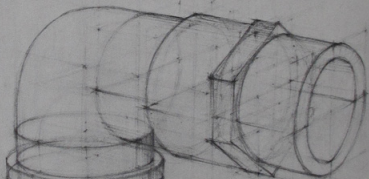
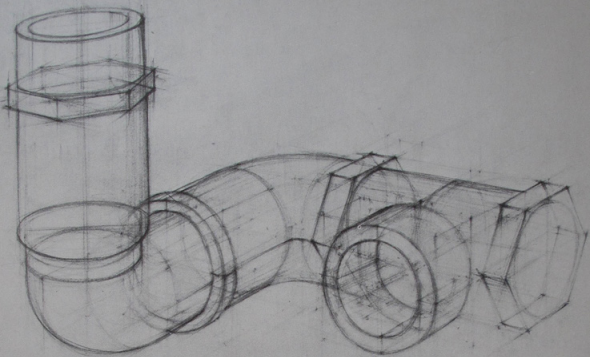

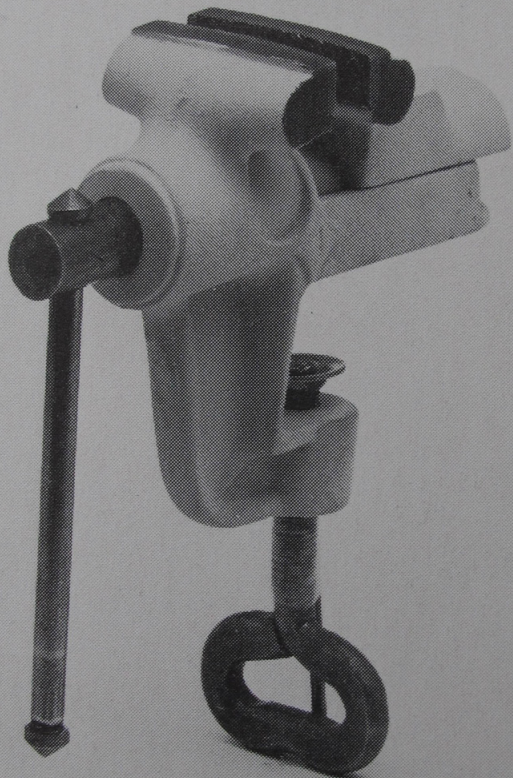

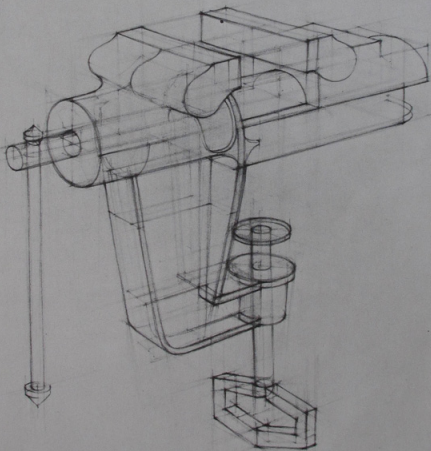
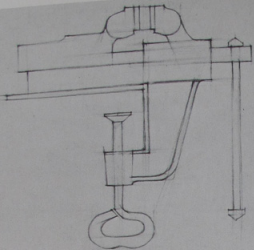





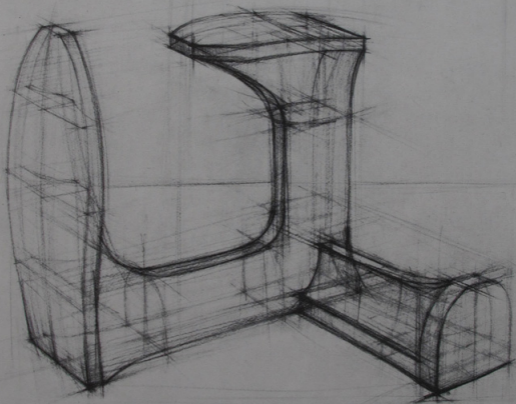
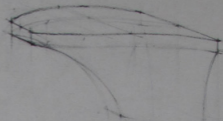
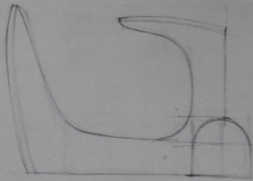

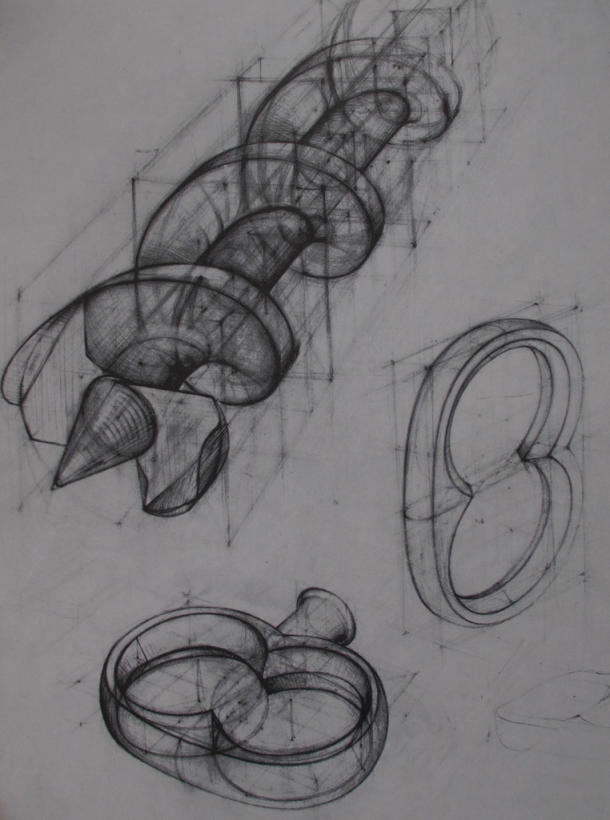

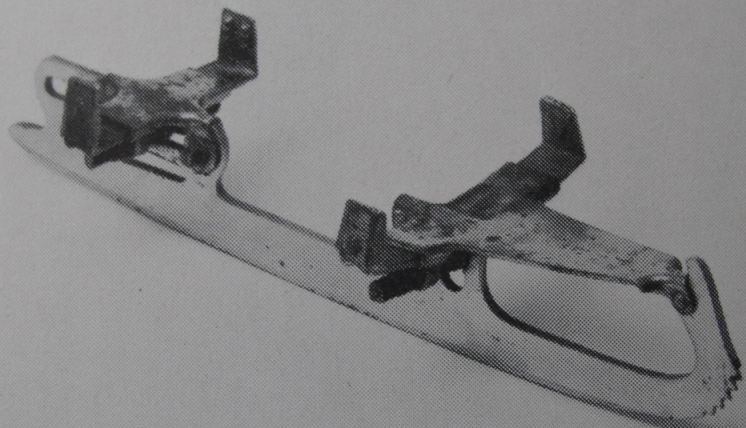

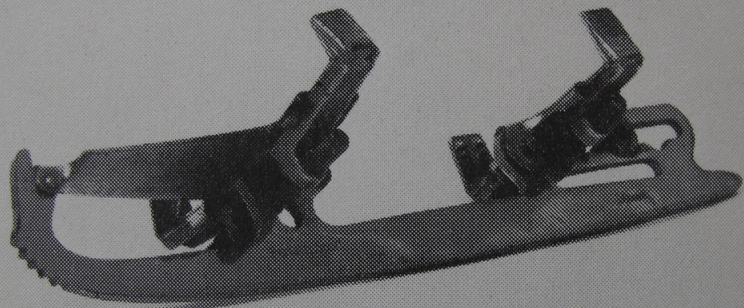

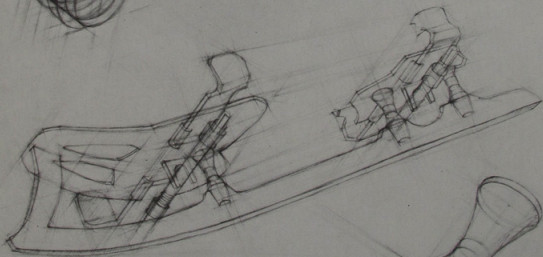
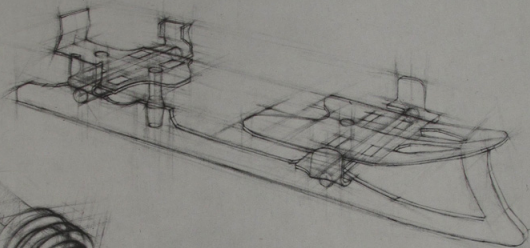
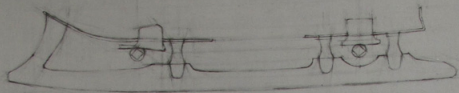

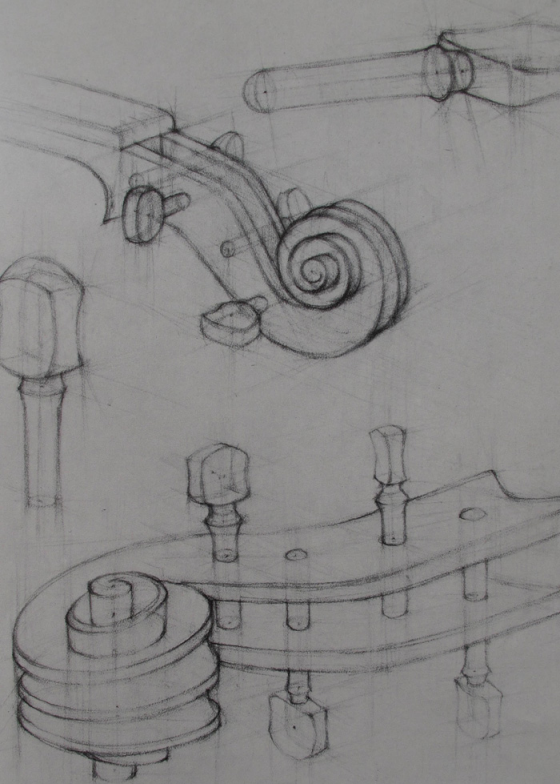

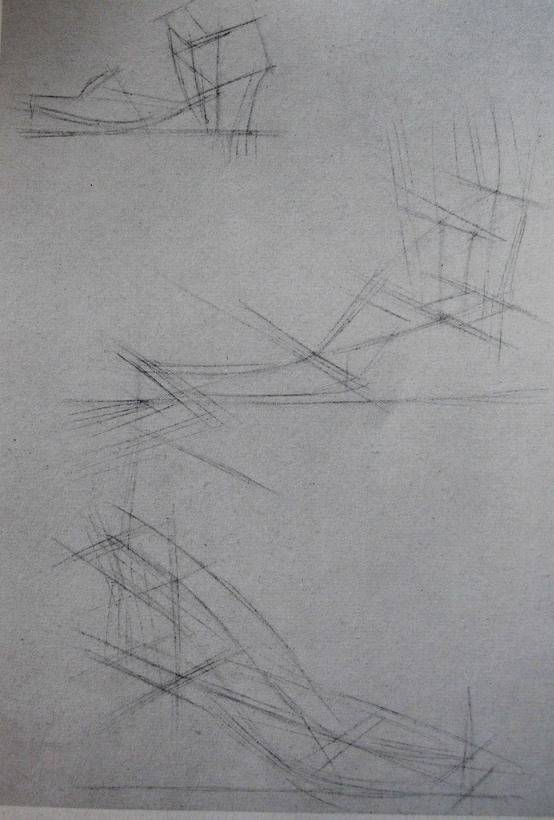

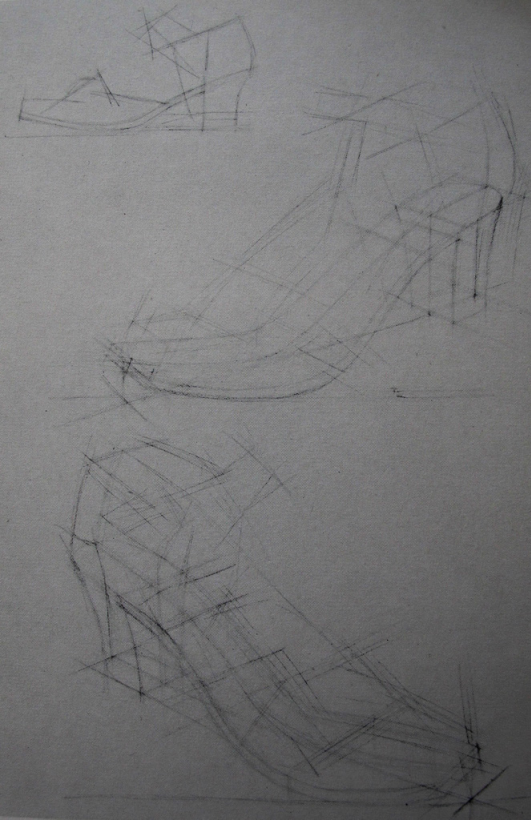

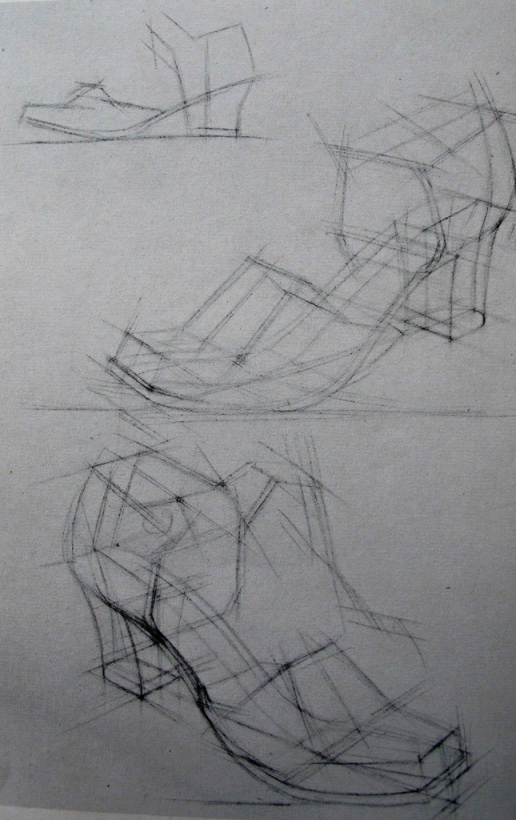

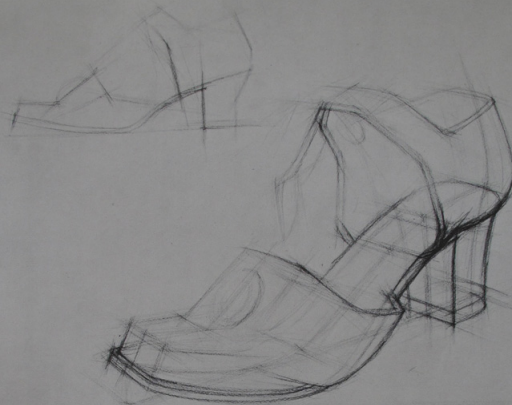

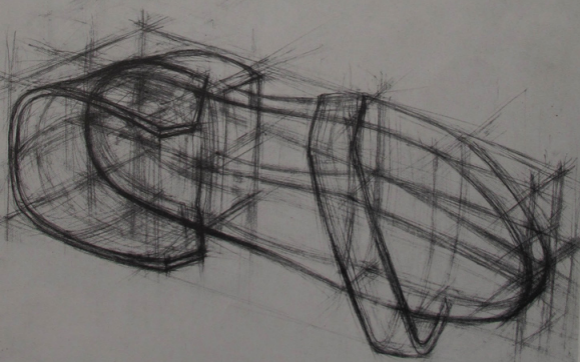

Wool Season

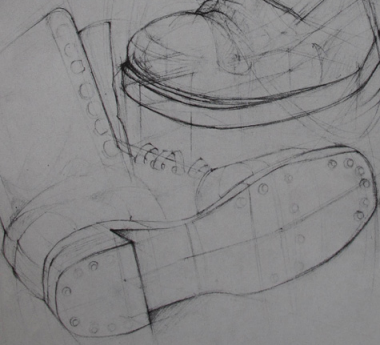



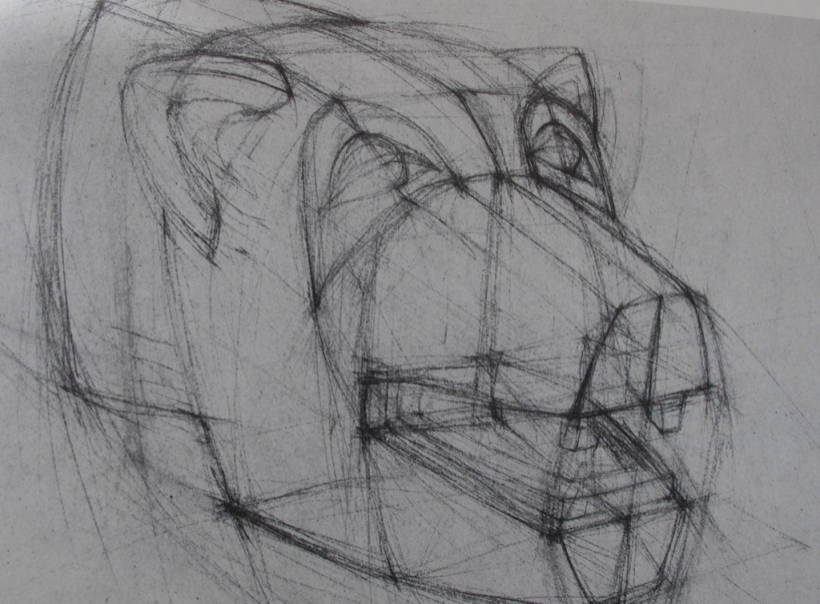

















R. B.







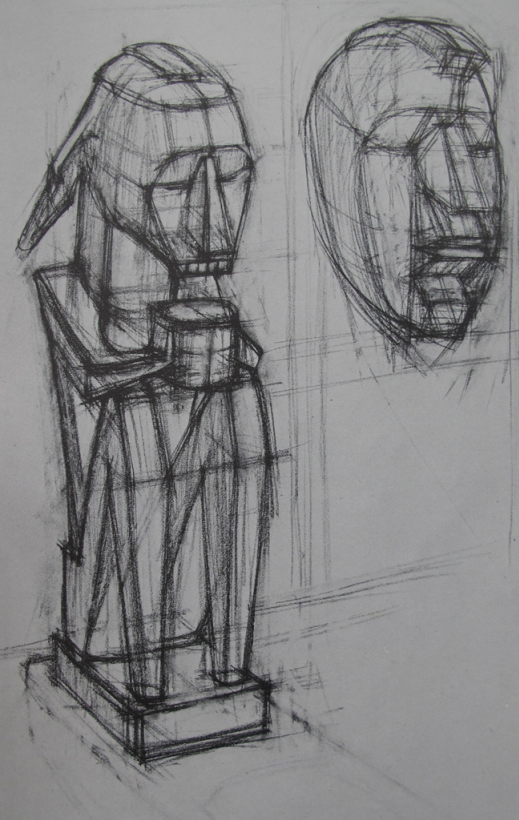





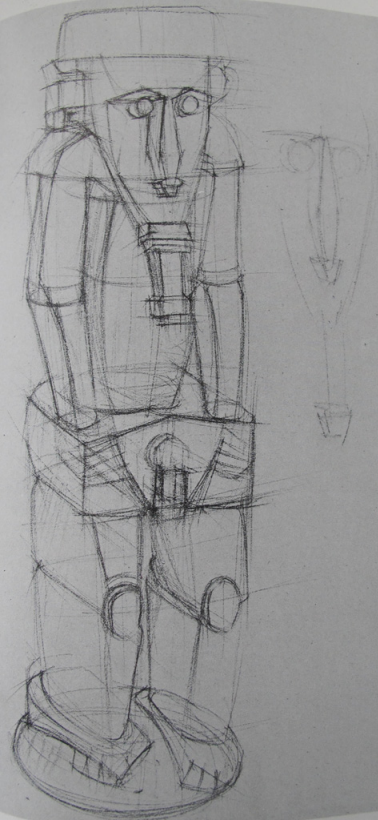



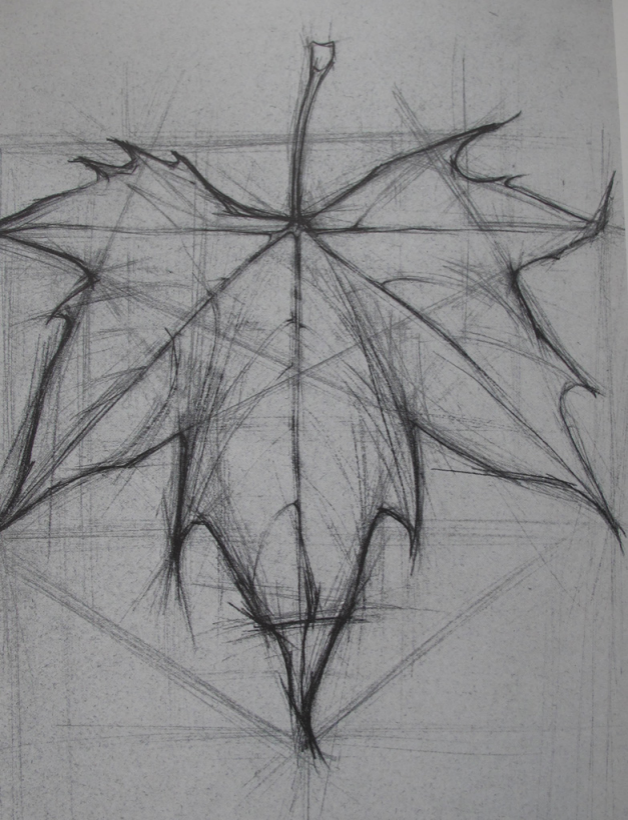

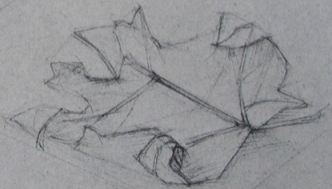
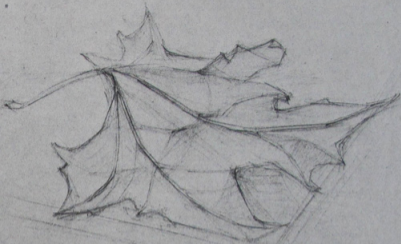

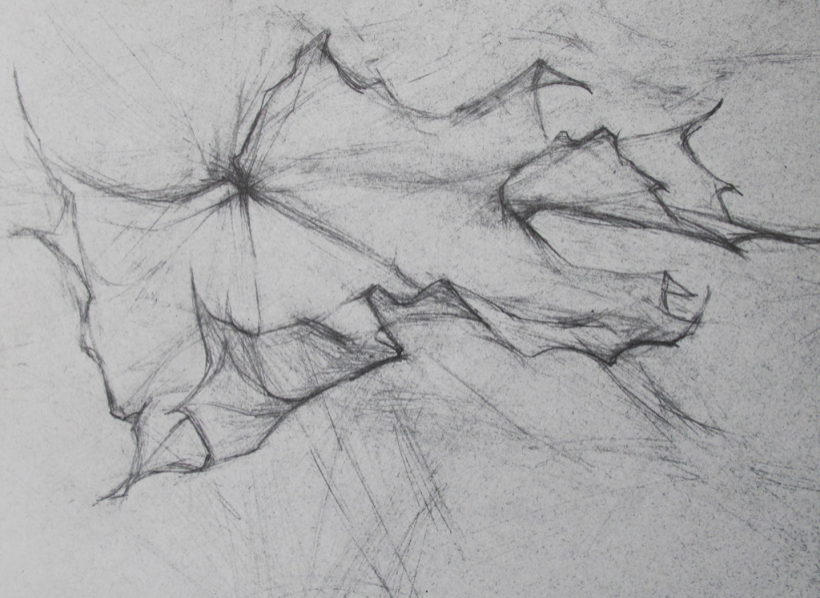













RYIGNI 1965





C. K. Z. 185









